

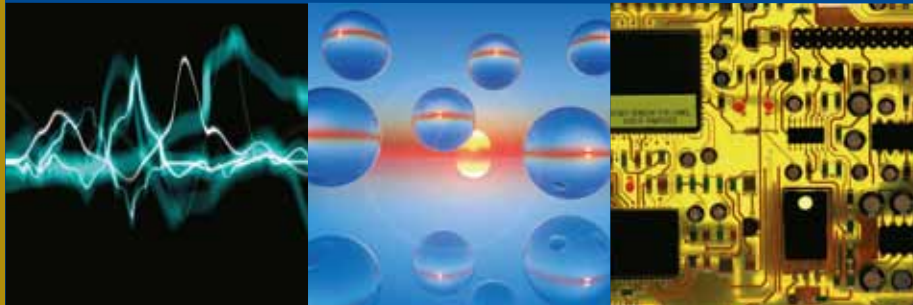

Solar/Photovoltaic Module Testing Chambers



Angelantoni
MORE THAN YOU THINK



Your partner for reliability

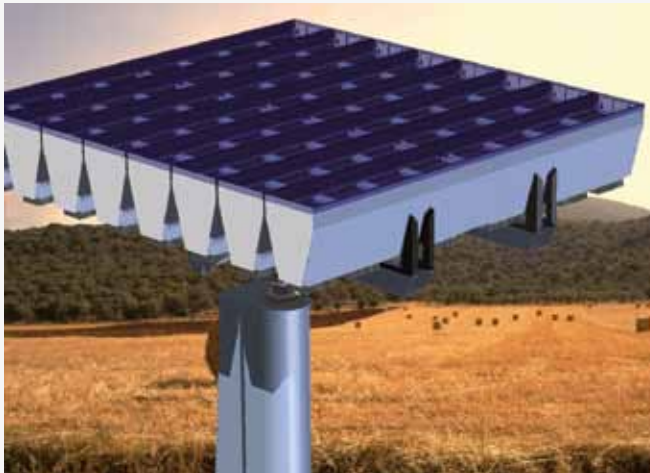

“Concentrating photovoltaic solar system”
by Angelantoni Industrie

Global warming caused by carbon dioxide emissions and the progressively reduced availability of fossil fuels are pointing towards the need to resort to a greater use of renewable energies.

Solar energy, which can be transformed into electricity and thermal energy, is one of the most interesting alternatives due to both its enormous availability as well as its potentials for development.

Thermal, photovoltaic and thermodynamic solar panels are the main tools used for “capturing” energy made available by the sun.

Along with research aimed at increasing the panels efficiency, an important consideration regards the panels wear and tear over time: no matter what they are made of, all types of panels must resist many years of adverse atmospheric conditions.

International standards have identified the kind of accelerated tests which involve simulating a product’s life cycle; these tests are a valid tool for activities concerning both product trials and product improvement.



“Parabolic troughs (CSP technology-Concentrated Solar Power) with solar receiver tubes manufactured by ASE, Archimede Solar Energy of Angelantoni Group”

Standard Test Methods

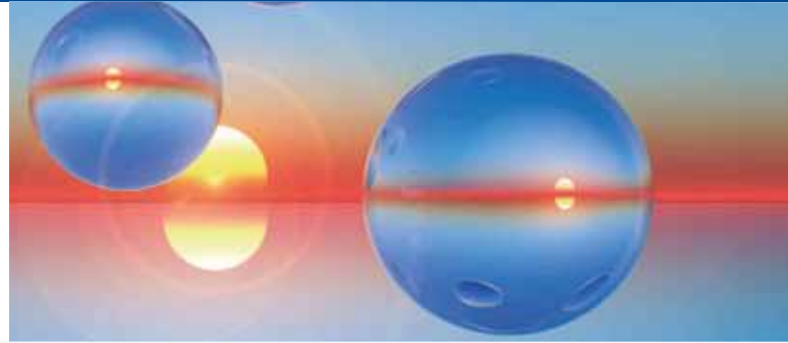

Standard Test Methods are established by the following norms

For Photovoltaic Modules:

- IEC 61215 Terrestrial crystalline silicon photovoltaic (PV) modules
- IEC 61646 Terrestrial thin-film photovoltaic (PV) modules
- IEC 62108 Concentrator photovoltaic (PV) modules and assemblies

For thermal modules:

- EN12975-1
- EN12975-2

Sample tests:

Temperature shock cycling test

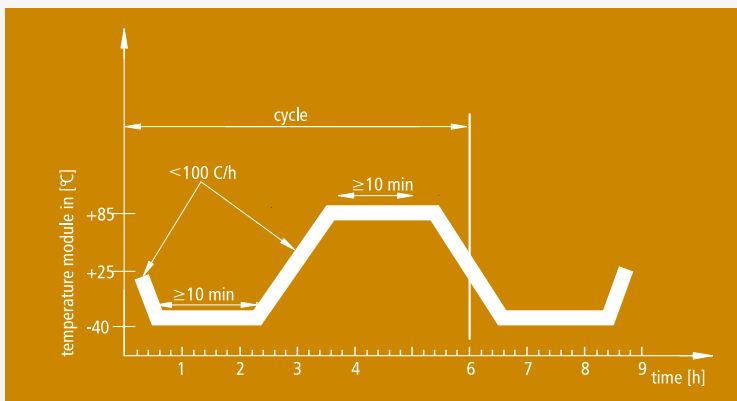

Humidity freezing test

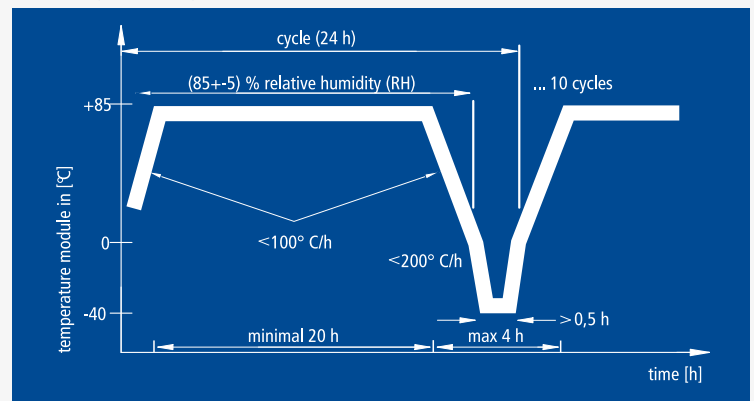

Damp heat test

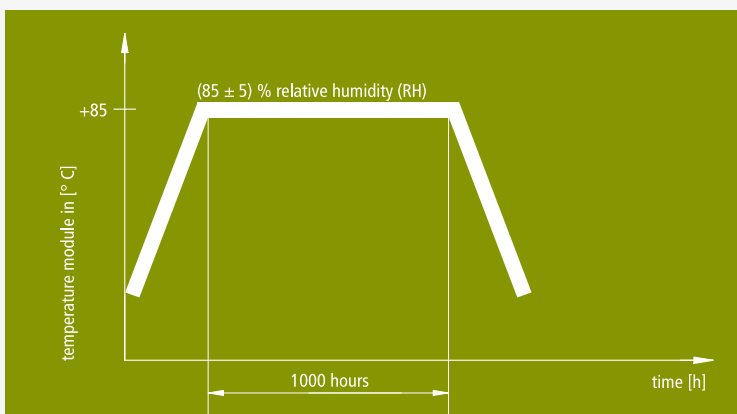

UV preconditioning test

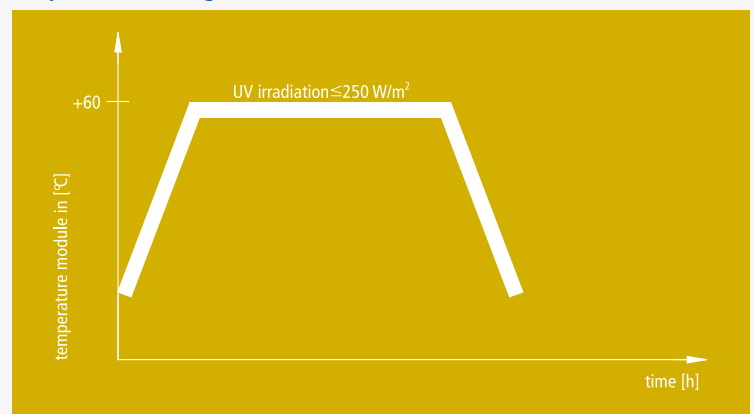



Standard chamber line

	PV3000 single-unit	PV4500 single-unit	PV8500 walk-in
Useful Capacity (l)	3300	4290	8250
Internal dim. (mm)	W	1000	1300
	D	1500	1500
	H	2200	2200
Max load (Kg)*	200	300	450
Dissipation (W) T ≥ 0°C*	2500	3500	5000

*Max values of load and dissipation to guarantee the test execution according to the norms.

ACS line of standard chambers dedicated to Photovoltaic Modules testing includes 3 models:

PV3000, PV4500, PV8500

- Full opening door
- Welded internal structure
- T range: from -50°C to 90°C
- T variation rate (with load):
 - <100°C/h in the range +85°C/0°C
 - <200°C/h in the range 0°C/-40°C
- RH range: 20%/95% in the T range +10/+90°C



SINGLE-UNIT



WALK-IN

To make your life easier

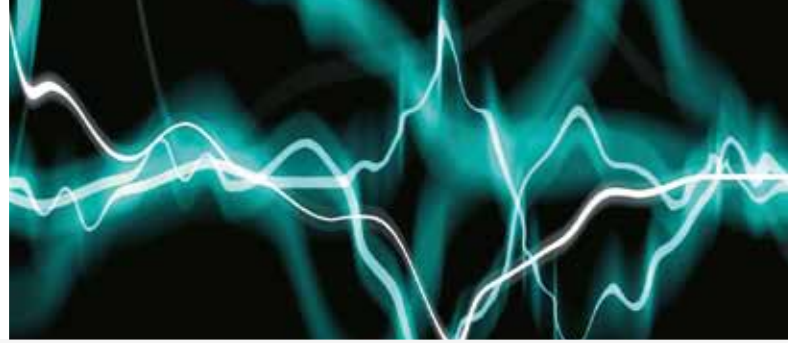

In order to improve the efficiency of your testing laboratory we designed a standard line of basic climatic chambers specifically fit to carry out the simple but long-term Damp Heat Tests required by the Standard Test Methods (85°C; 85% RH for 1000 h), whilst leaving to the more performing chambers the task of executing the more complex tests.

DAMP HEAT TEST CHAMBERS PV3000 DH, PV4500 DH, PV8500 DH

- Full opening door
- Welded internal structure
- T range: from +50°C to +90°C
- RH range: 70%/90%

	PV3000 DH single-unit	PV4500 DH single-unit	PV8500 DH walk-in
Useful Capacity (l)	3300	4290	8250
Internal dim. (mm)	W	1000	1300
	D	1500	1500
	H	2200	2200

UV RADIATION PRE-TREATMENT THERMAL CHAMBER UV3000

Useful volume:	3520 l
Useful dims (WxDxH):	1000x1600x2200 mm
Temp. Range:	from ambient to 90°C
UV wavelengths:	from 280 to 400 nm
UV irradiation uniformity:	+/-15%
UV power:	to be defined

HAIL TEST

We are also able to provide you with the right tool to carry out the test procedure for determining the ability of photovoltaic modules to withstand impact forces of falling hail. Propelled ice balls are used to simulate falling hailstones.

Contact us for further details.

DAS (Data Acquisition System)

We have developed a software application for the data acquisition and management of your specific test parameters. The measurements taken into consideration are primarily related to the electric field (voltage, current, wattage, etc.) for **photovoltaic panels**. DAS is also available for **thermal panels** (water temperature, flow, pressure, etc.). In both cases it is possible to also acquire ambient parameters such as solar radiation, surrounding temperature, wind speed, etc., according to your specific needs.

The Standard Test Methods for Photovoltaic Modules require also an UV radiation pre-treatment phase. To this aim we can offer you a specific thermal chamber having the following features:



Control Systems

KEYKRATOS PLUS

KeyKratos Plus is the new standard user interface able to speed up programming functions thanks to the color touch screen equipped with icons that allow immediate movement to the available windows with one simple touch of the screen. Every icon is made to easily show how to reach the right window; on line help allows the user to find the required item in any window he is working and set up the test in a short time.

The touch panel has the following main features:

- ⊗ Graphics-compatible LCD display, 1/4 VGA resolution
- ⊗ Resolution: 320x240 pixels
- ⊗ Display of actual values
- ⊗ Possibility to set easily customized programs
- ⊗ Saving and reactivation functions

It is connected directly to the hardware structure of the chamber (PLC).



WINKRATOS (OPTIONAL)

WinKratos is the new-generation control and management system running under Windows XP/Vista/7. Powerful and flexible, WinKratos offers many innovative features and it allows the user to:

- ⊗ create test programs
- ⊗ refer to and modify previously created test programs
- ⊗ delete all test programs that are no longer necessary
- ⊗ print any test program in text format

Main features

- ⊗ Connection to PLC through serial port (multiple serial ports allowed for control of more than one chamber from the same PC)."
- ⊗ Colour printing of charts.
- ⊗ Multiple levels of password protected access.

Graphic functions

- ⊗ Fully-configurable layout of acquired measures charts.
- ⊗ Display of several charts on the monitor.
- ⊗ Several colors to be chosen at one's choice for the display of different parameters curves.
- ⊗ Enable/disable of chart display and grids.
- ⊗ Real-time update of acquired measures charts.

Acquisition functions

- ⊗ Real-time measurement of test parameters by means of graphic cursors.
- ⊗ Max. flexibility for cycles to be set.
- ⊗ Storage of occurred events such as alarms, commands, etc.

WinKratos may be installed on PCs supplied by ACS or belonging to the customer.

Customized solutions

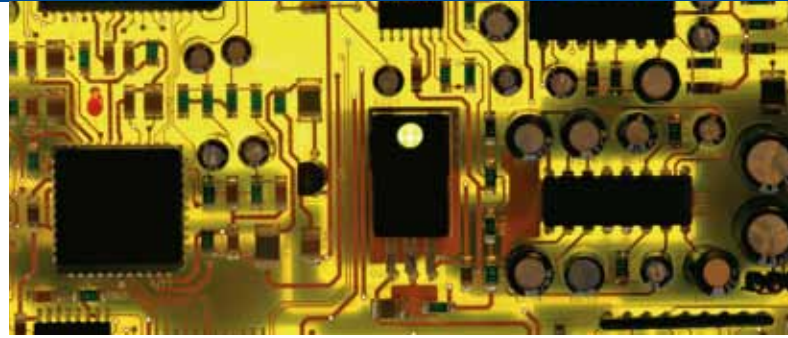

Customized walk-in chambers for tests on photovoltaic modules



Useful capacity: 33.75 m³



Useful capacity: 16 m³

UV Test walk-in chamber



Useful capacity: 16 m³

Angelantoni
MORE THAN YOU THINK



Angelantoni Test Technologies
Loc. Cimacolle, 464 - 06056 Massa Martana (Pg) - Italy
Tel. +39 075.89551 (a.r.) - Fax +39 075 8955200
info@acstestchambers.it

www.att-testing.com
www.acstestchambers.com

Subsidiaries
Ofterdingen, GERMANY
info@att-umweltsimulation.de

Paris, FRANCE
info@attfrance.fr

Beijing, P.R. CHINA
info@attasiapacific.com

Noida, INDIA
info@attindia.in

